

Double Flank Test Machines

The simple functional Inspection

*pure
perfection*

FRENCO

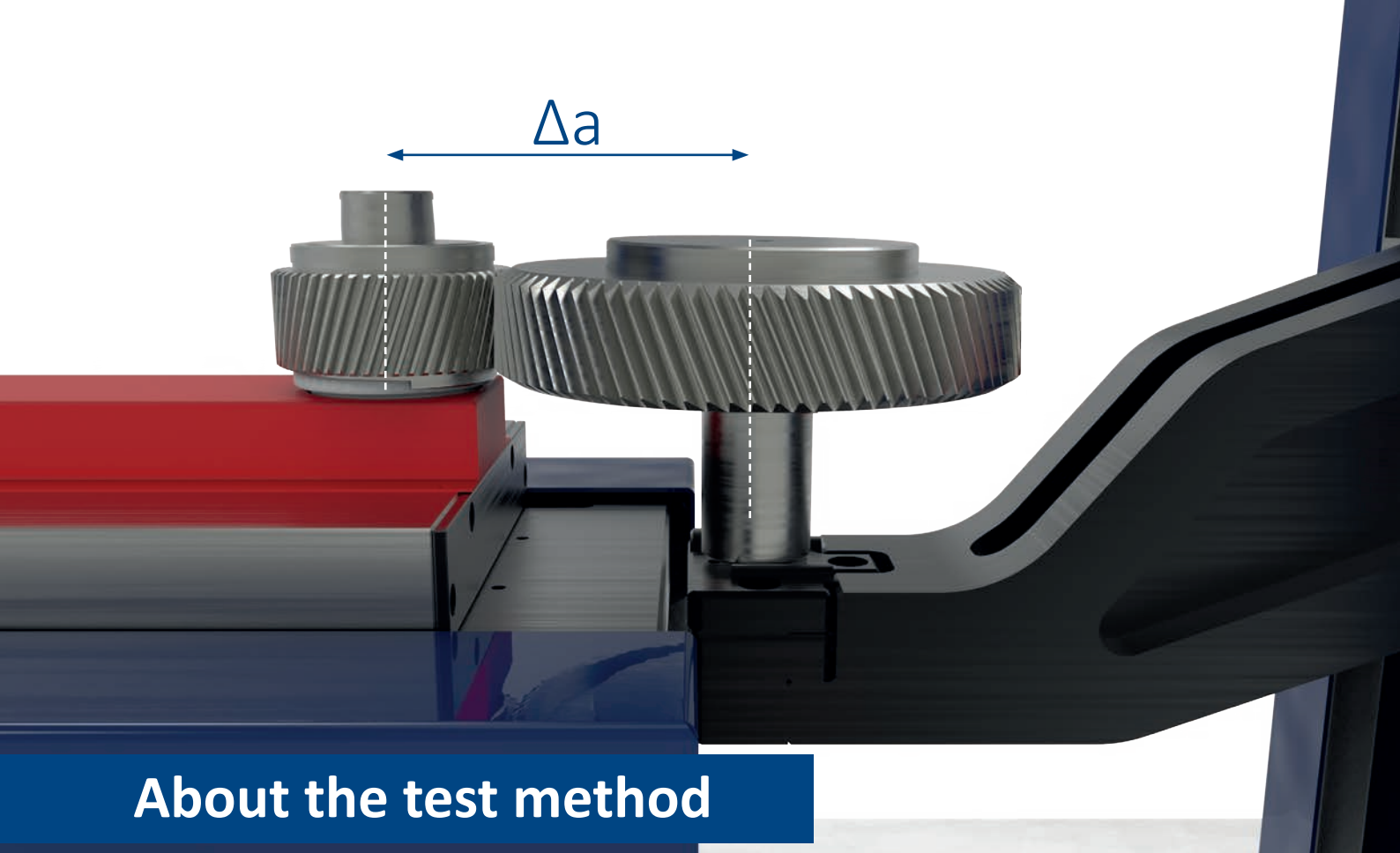

About the test method

Fundamentals of the double flank test:

The basic principle of the double flank tests is based on the fact that a test specimen with a theoretically faultless mating gear (master gear) rolls backlash-free under the influence of a force acting in the direction of the centre distance (measuring force). Under the influence of the measuring force, a right and a left flank always remain in mesh: the two-flank contact. The testing device is designed in such a way that one axis of rotation is fixed and one axis of rotation is variably mounted (= measuring slide). The measuring slide movements or the changes of the centre distance „a“ are measured during one rotation of the gear to be measured (test specimen). The basic characteristic values „Fi“, „fi“ and „Fr“, which are typical for the double flank test, are determined here and serve as the basis for assessing the gearing with regard to the production-related faults.

What we can offer you:



Client-specific design:

Optimal adaptation to your demands



Suitable for manufacturing:

Highest precision under toughest conditions



Sophisticated know-how

Special calibration artefacts, low-wear construction, temperature compensation



Own software:

Fast support for questions and problems



Service:

Carried out by FRENCO specialists



Retrofit:

Mechanical and electronic upgrade of older devices

Applications



The double flank test is a fast and simple functional test method for gears.

The basic characteristic of the double flank test is to evaluate all occurring centre distance fluctuations or centre distance changes „ Δa “ during one test piece rotation as a total error. The the double flank test is therefore a classic sum error test.

Sum error testing means, on the one hand, that the measurement result is composed of the sum of the errors of the two gears to be rolled off (all determined errors, also the errors of the master gear existing in practice, are assigned to the test piece) and, on the other hand, of the sum of all individual errors of both flanks together (double flank contact!), which occur on both gears to be rolled off, such as concentricity errors, pitch errors, flank line errors, etc. The result of the measurement is also determined by the sum of the errors of the two gears to be rolled off.

Conclusions as to which error is caused by which gear or which part is caused by which individual error cannot usually be drawn!

The double flank test is a functional test that approximately reflects the later fitting situation and therefore tests the later mounted condition very practically.

Product range

The right instrument for every application.



ZWP 06

For small internal and external toothed spur gears, worm gears and worms



ZWP 14/14M/24M

For externally toothed spur gears, worm gears and worms



ZWP 28

For internal and external spur gears, worm wheels and worms | Measuring room suitable

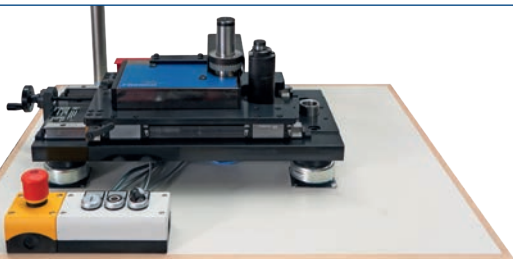

Automatable devices

For internal and external toothed gears | Peumatic measuring slide - flexible for conversion to other centre distances | PROFINET interface

ZWP 30

For large and heavy internally and externally toothed spur gears, shafts and worms



Product range

The technical data in comparison.

	ZWP 06		ZWP 14 (24 M/MP)*		ZWP 28		ZWP 30	
	single end	between tips	single end	between tips	single end	between tips	single end	between tips
Range of centre distance (depending on version)	12 – 85 mm	12 – 85 mm	50 – 320 (50 – 390)* mm	50 – 150 (50-220)* mm	38 – 128 mm	38 – 128 mm	62 – 360 mm	62- 360 mm
Minimum centre distance (special fixtures required)	10 mm	10 mm	20 mm	20 mm	20 mm	20 mm	-	-
Max. diameter of specimen	80 mm	80 mm	400 mm	160 mm	180 mm*	180 mm*	460 mm*	460 mm*
Centre height size with steady centre attachment	-	40 - 100 mm	-	0 - 370 (0 - 420)* mm	-	0 - 360 mm*	-	190 - 790 mm*
Range for height adjustable single end mounting	•		on request		•		•	
2nd steady centre attachment	-		o		o		o	
Adjustment of measuring force	0 - 5 N		3 - 30 N (adjustable by cylinder MP)*		2,5 - 19 N		adjustable by cylinder	
Glass scale	o		-		o		o	
Sensor for corrections of deviations of master gears	on request		o		-		on request	
Range of application	small workpieces and plastic gears		large workpieces; robust for shop floor use		medium-sized workpieces; suitable for inspection laboratories		large wheels, worms and shafts, designed for heavy weights	
Motor drive	•		o		•		•	

• standard

o optional

*The specified technical data are standard values and can be adjusted on request to customer wishes.



Model ZWP 06

Specialist for small and high precision gears

The double flank tester is specially designed for small high-precision gears. It is also suitable for plastic gears. The measuring force can be lowered to 0 N.

The sophisticated design is extraordinarily precise and sensitive. The measuring carriage is supported free from backlash on four leaf springs. This so-called parallelogram suspension is very sensitive and registers even the smallest change in centre distance.

The measurement process is motor driven by default. We recommend the FRESCO Software 'FGI pro' for the evaluation. This will enable you to control the quality of your workpieces easily, efficiently and reliably.



Technical Data	
Centre distance with special mounting	12- 85 mm ≥ 10 mm
Max. specimen diameter	80 mm
Height adjustable	yes
Steady centre attachment on both sides	no
Measuring force setting	0 - 5N

steady centre attachment

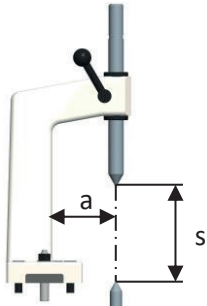

$s = 40 - 100 \text{ mm}$
 $a = 40 \text{ mm}$

For small centre distances:

Pin arbor attachment



Pin
 $d = 0,6 - 8 \text{ mm}$

centre fixture

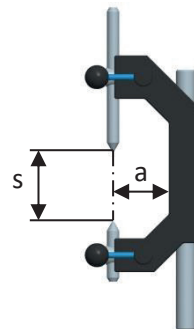

$s = 15 - 50 \text{ mm}$
 $a = 20 \text{ mm}$

fixture for internal gears and splines

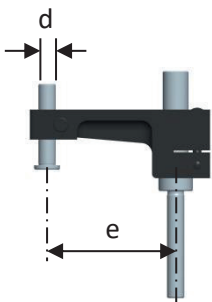

$d = 8 \text{ mm}$
 $e = 60 \text{ mm}$

fixture for worms, fixture between tips

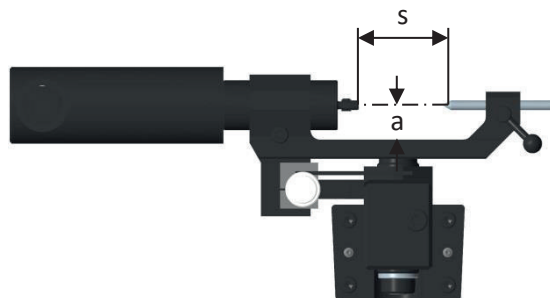

$s = 15 - 50 \text{ mm}$
 $a = 16 \text{ mm}$



Modell ZWP 14 / 24

Simple, robust, designed for shop-floor use

The variants of the ZWP 14/24 are robust double flank inspection machines and are therefore particularly suitable for use on the shop-floor. They differ in the composition and length of the machine base. The construction of the measuring slide and the mounting of the fixtures in the device bed slot are the same for all variants

The device can be operated manually as well as by motor. There are two possibilities for motor operation: The in-house measuring electronics MEG32 with extensive software evaluation FGI pro or the operation with a simple motor control. The measurement results are displayed either on a fine pointer or a digital dial gauge.

As an alternative to the cast version of the ZWP 14, it is also available in a modular design as the ZWP 14M and in a longer, modular design as the ZWP 24M. The device can also be equipped with a pneumatically controlled measuring slide as ZWP 24MP. The modular design as well as a wide range of accessories allow an individual adaptation to your needs. Individual solutions for your measuring tasks are also possible.



Technical Data		
	ZWP 14	ZWP 24 M/MP
Centre distance with special mounting	50- 320 mm ≥ 20 mm	50- 390 mm ≥ 20 mm
Max. specimen diameter	400 mm	400 mm
Height adjustable	on request	on request
Steady centre attachment on both sides	optional	optional
Measuring force setting	3- 30N	

steady centre attachment small

$s_{MAX} = 370 \text{ mm}$
 $a = 82 \text{ mm}$

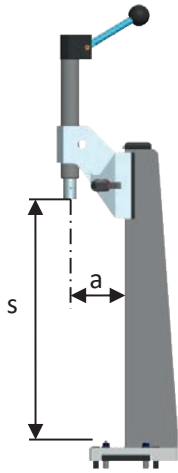

steady centre attachment large

$s_{MAX} = 420 \text{ mm}$
 $a = 160 \text{ mm}$

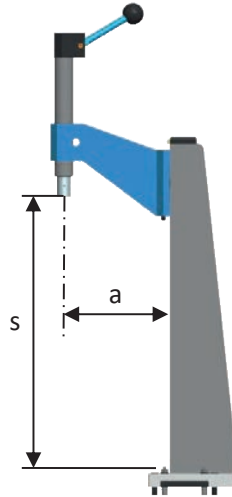

Adapter for small centre distances: centre fixture

$s_{MAX} = 140 \text{ mm}$
 $a = 46 \text{ mm}$

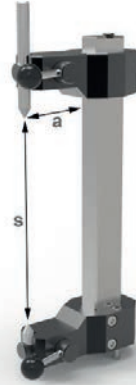

Fixture for worms, mounting between tips

$s_{MAX} = 150 \text{ mm}$ $w = \pm 45^\circ$
 $a = 40 \text{ mm}$

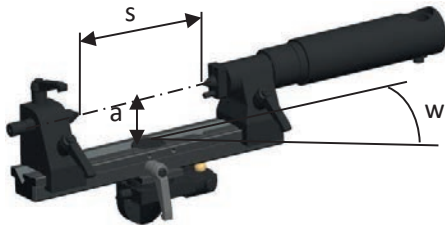

Fixture for worms, mounting trough prisms (bearing seat as reference)

$s_{MAX} = 250 \text{ mm}$
 $a = 40 \text{ mm}$

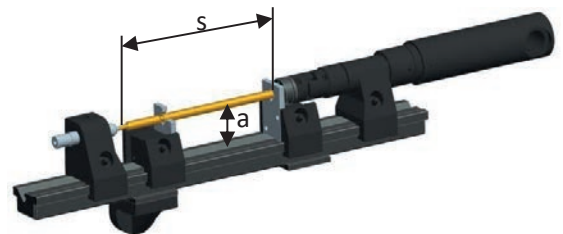

Fixture for worms, height adjustable through crank handle, fixed version

Stroke = 100 mm

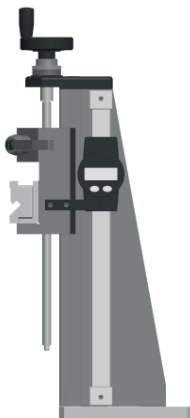

Adjustable quill

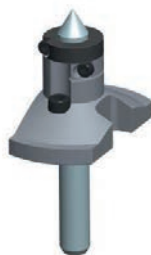

Fine adjustment



Adapter for small centre distances: Pin arbor attachment



pin
 $d = 1-16 \text{ mm}$



pin
 $d = 4-22 \text{ mm}$

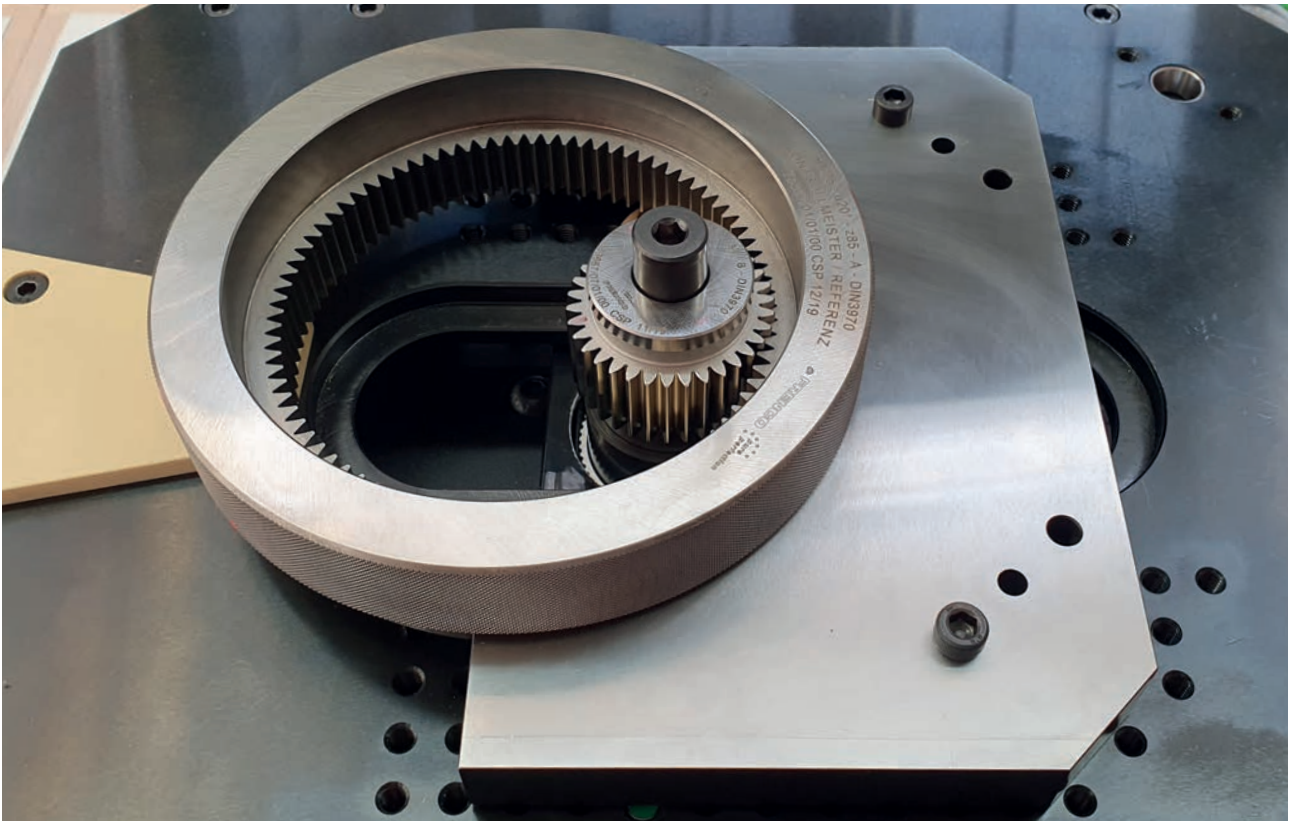

ZWP for internal gears



ZWP 24M

FRENCO drive control

There are 2 options here:

The MEG32 measuring electronic runs with the FGI pro evaluation software (for details see page 16/17). This is our comfortable package with large evaluation options. A high-quality slot PC can be built into the MEG32 electronics or an external PC can be connected.

The other option is the FRENCO Motion Control. It has the functions: Motor start / stop, direction change, speed control knob and emergency stop switch.

In combination with a digital dial gauge with MAX-MIN function, the double flank gear rolling error F_i'' can be determined. The dial gauge should have a fast mode that can record at least 50 measured values per second.

The drive control can also be integrated into the front panel of the inspection machine.

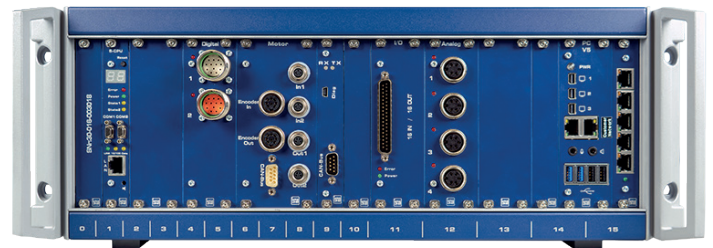

Frenco measuring electronics MEG32 for control and evaluation



Automatable devices

The ZWP14A is an automatable double flank gear roll inspection instrument. The measuring slide moves pneumatically forwards and backwards. There is one variant for internal and one variant for external gearing.

The device can be connected to the handling system via I/O ports or Profinet® (Profibus®). Communication via I/O ports is a simplified solution. Here, the ZWP 14A is connected directly to the handling system via 16 digital input-output ports. In this case, communication is limited to what is absolutely necessary. The feedback after the measurement is reduced, for example, to whether the measured part is within (OK) or outside (NO) the tolerance or intervention limits.

If the connection is done via Profinet®, the Inspection Task Manager (ITM) is used as FRENCO's own interface between 'FGI pro' and Profinet®. The ITM controls 'FGI pro' on the one hand and communicates with the handling system on the other. For example, it transfers the current status of the measuring instrument (ready, loaded, empty, finished), the individual measurement results and the inspection plan name to the handling system.



ZWP 14 A



ZWP 28

Robust design with granite machine base for highest accuracy

The high-quality ZWP 28 is characterized by an extremely stable construction and thus enables measurements of highest accuracy. The setting value of the axis distance is kept by a scale, even if the carriage is moved. An exact height adjustment at the steady centre attachment is done by cranks. The very flexible construction makes adjustments as well as the assembly of many accessories possible without any problems. Optionally, the ZWP 28 is also available in a flying version- i.e. without accessories for the upper tip.

Technical Data	
Centre distance with special mounting	38 - 128 mm ≥ 20 mm
Max. specimen diameter	180 mm
Height adjustable	yes
Steady centre attachment on both sides	optional
Measuring force setting	2,5-19 N



Optional accessories

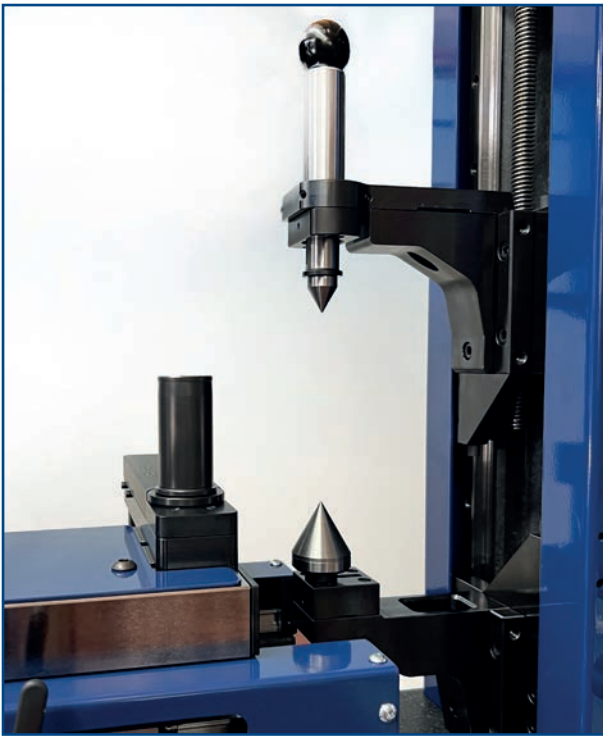

Mounting for internal gear inspection, for mounting of master gear

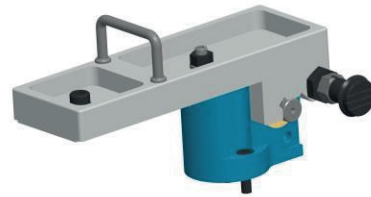

Mounting between tips

$s_{MAX} = 150 \text{ mm}$
 $a = 40 \text{ mm}$
 $w = \pm 45^\circ$

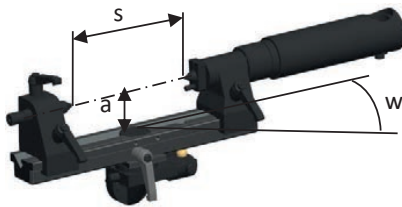

mounting trough prisms (bearing seat as reference)

$s_{MAX} = 250 \text{ mm}$
 $a = 40 \text{ mm}$

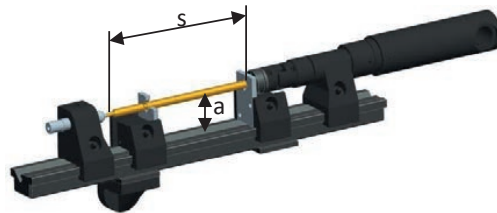

**Adapter for small centre distances:
 Pin arbour attachment**



pin
 $e_{MIN} = 16 \text{ mm}$

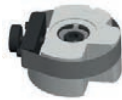

pin
 $e_{MIN} = 22 \text{ mm}$

**Adapter for small centre distances:
 centre fixture**

$s_{MAX} = 140 \text{ mm}$
 $a = 46 \text{ mm}$



ZWP 30



Our Specialist for large Gears, Shafts and Worms

- Workpieces:** Gears with borehole, shafts between tips
- Characteristics:** Composite deviations of double flank gear rolling inspection, centre distance
- Measuring time:** 10 to 20 sec.
- Accuracy:** Minimum tolerance of workpiece $T_{\min} \geq 10 \mu\text{m}$, determined by method 2 made with master pieces.
- Solution:**
- large machine with steady centre attachment
 - compact frame incl. electronics and PC
 - linear scale within the whole measurement range
- Software:**
- user-friendly software FGIpro
 - graphical display of values
 - extensive options, data export, various languages
- Features:**
- high precise granite base
 - ergonomic arrangement of controls
 - height widely adjustable, 30 mm opening path
- Options:** Fixture for worms

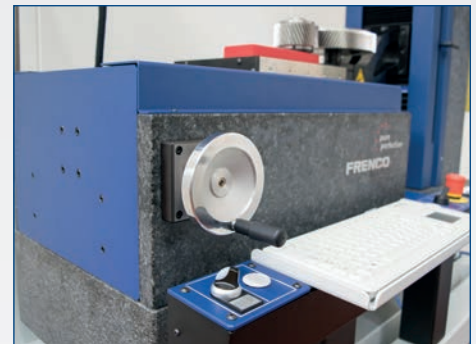

Technical Data	
Centre distance	70 – 330 mm
Max. diameter of specimen	500 mm
Centre height size with steady centre attachment	160 – 750 mm
Adjustment of measuring force	4- 40 N, adjustable by cylinder
Length x width x height	1185 mm x 620 mm x 2010 mm
Weight	770 kg



Evaluation FGIpro

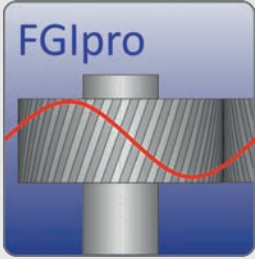

FRENCO - Software for Gear Evaluation on Double Flank Tester

FGI pro includes both, the control of the drive via MEG32 and the evaluation software. The software is in-house developed and programmed by FRENCO specialists. This enables us to offer you the best possible support.

The software determines the following values:

- total radial composite deviation F_i''
- tooth-to-tooth radial composite deviation f_i''
- runout deviation by composite test F_r''
- short-wave component f_k''

and after center distance adjustment:

- centre distance Cd''
- dimension over balls Dob''
- tooth thickness S_n'' and span size W_k''

The roll scan curve can also be subjected to an FFT analysis. The amplitude spectrum for rough estimation of noise development is determined this way.

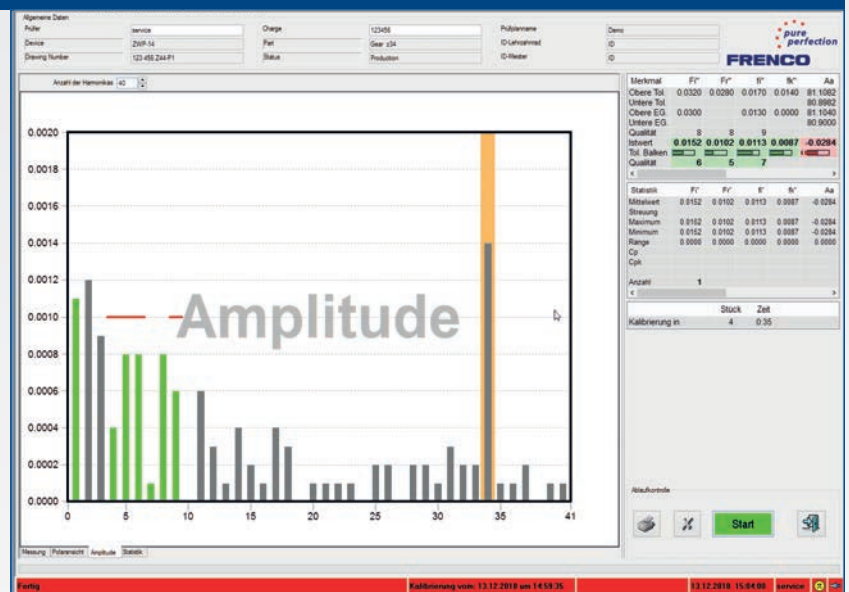

- Colour coding and tolerance bar for fast o.k. / n.o.k. evaluation
- Easy input and modification of test option
- Automatic positioning on damages after measurement (Features selectable)
- Flexible language selection (German, English, French, Polish, Portuguese, Hungarian, Chinese)
- Different program and output languages (Unicode support)
- Archiving function saves all measurements
- Central statistical evaluation through interfaces fast and easy realizable (qs-STAT® and ASCII interface)
- Integrated user administration with user groups
- Customer-specific expansion options

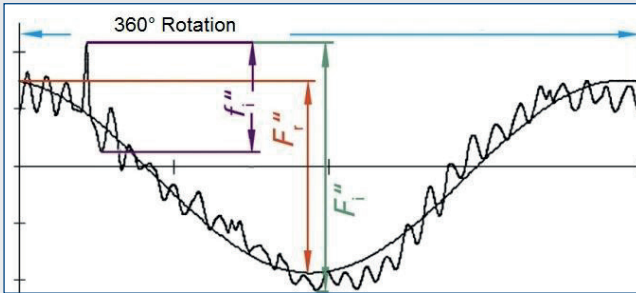
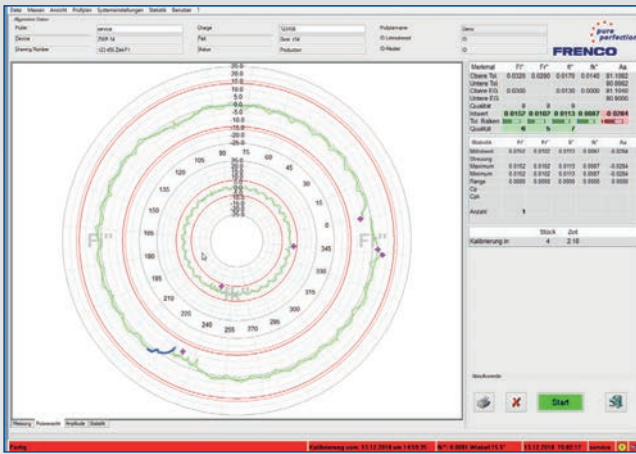

The letter symbols of the features include the two additional quotation marks “ ($F_{i''}$, $f_{i''}$, F_r'' , Cd'' , ...) so that they can be easily distinguished from other measurement techniques.

Records

A log file is created for each measurement; this file contains all inspection plan data and all of the raw data. It is therefore possible to re-evaluate the entire measurement at any time and to graphically display the results. Each inspection record can also be printed out.

It is also possible to combine several measurements and print a summary.

Parameters

Radial composite error F_i''

F_i'' is the fluctuation of the centre distance Cd'' , i. e., F_i'' is the difference between the largest and the smallest centre distance Cd'' during one rotation of the inspected gear (DIN 21772/3963).

Radial tooth-to-tooth composite error f_i''

f_i'' is the largest difference between the centre distance Cd'' , which occurs at an angle of rotation corresponding to the duration of engagement of one tooth (DIN 21772/3963).

Radial run-out F_r''

F_r'' is the long wave-length component of the radial-composite deviation. It is obtained by adding the mean line to the inspection graph of the double flank-measurement, in which the short wave-length components are suppressed. The radial run-out F_r'' is therefore the distance between the highest and lowest point of the 'mean line' (DIN 21772/3963).

The letter symbols of the features include the two additional quotation marks “ ($F_{i''}$, $f_{i''}$, F_r'' , Cd'' , ...) so that they can be easily distinguished from other measurement techniques.

Data export

The FGIpro software exports all calculated features in the qs-STAT® ASCII transfer format2. The configuration of the K fields is achieved via a modifiable definition file.

The measurement values and results can also be saved to normal text files or Excel® spreadsheets. Sample files and placeholders can be used to detail the layout of these files.

Additional export formats on request.

Indirect determining of dimension over two balls, span size and tooth thickness

If the actual centre distance is to be measured, it is necessary to calibrate the machine with known centre distances. The easiest way to do that is by using shafts, discs and gauge blocks. Please note that the measurement uncertainty increases when tolerances (e.g. of the bore of the workpiece) are large. In this case, the actual dimension of the bore can be measured (see page 19). A toothed version is also available for automation.

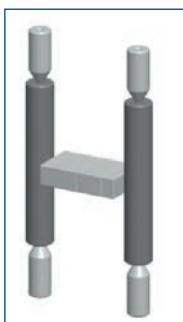

Setting master shaft - gauge block - shaft

Setting master disc - disc

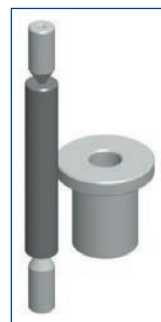
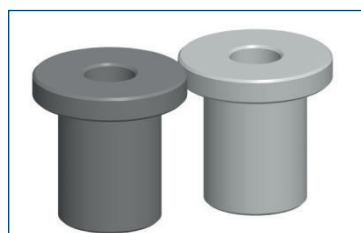

Setting master shaft - disc

Setting master with discs on shafts

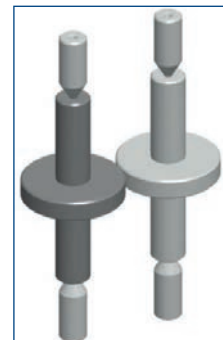

Calculating the Dimension over Balls DOB''

For the double flank gear test, the variations in centre distance during one full rotation are detected and displayed as a roll curve.

The roll curve comes up to the radial changing of the specimen compared to a master gear, almost free from errors. Adjusting the gear tester with known centre distances (setting masters) the absolute value is known and can be converted to the radial ball dimension of the specimen.

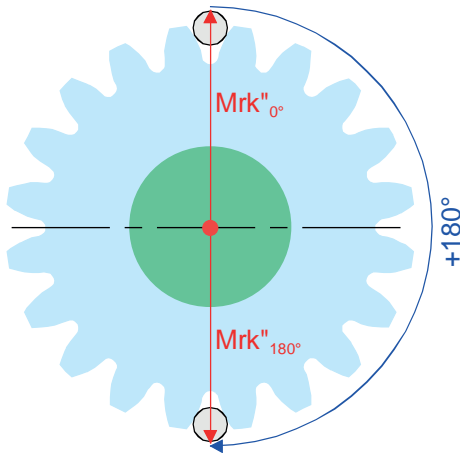

To receive an estimate of the dimension over balls DOB'' all opposed radial ball dimensions MrK'' (+180° at even number of teeth) are added.

Similar to a real measurement, an eccentricity does not affect this value.

At even number of teeth: +180°
 (At odd number of teeth: +180° ± π/z)

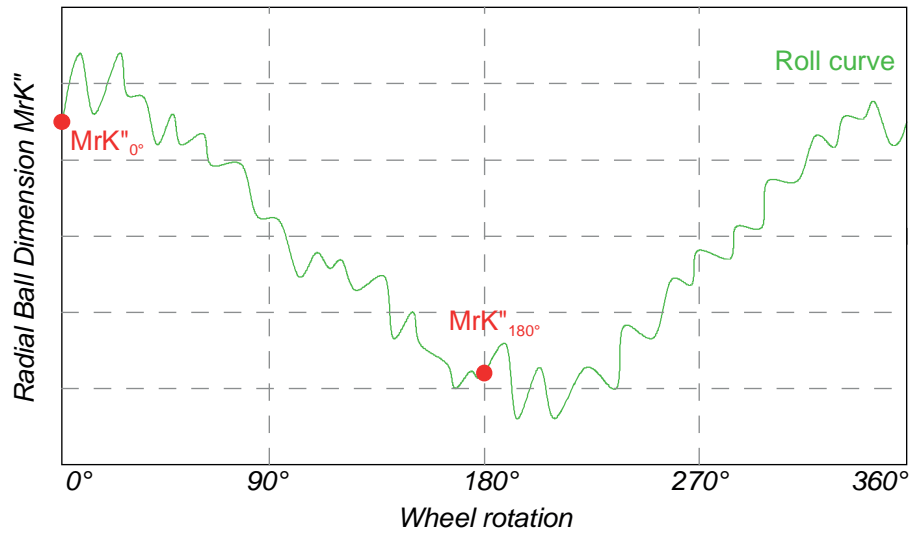

$$DOB''(z) = MrK''_i + MrK''_{i+180°}$$

in example:

$$DOB''(1) = MrK''_{0°} + MrK''_{180°}$$

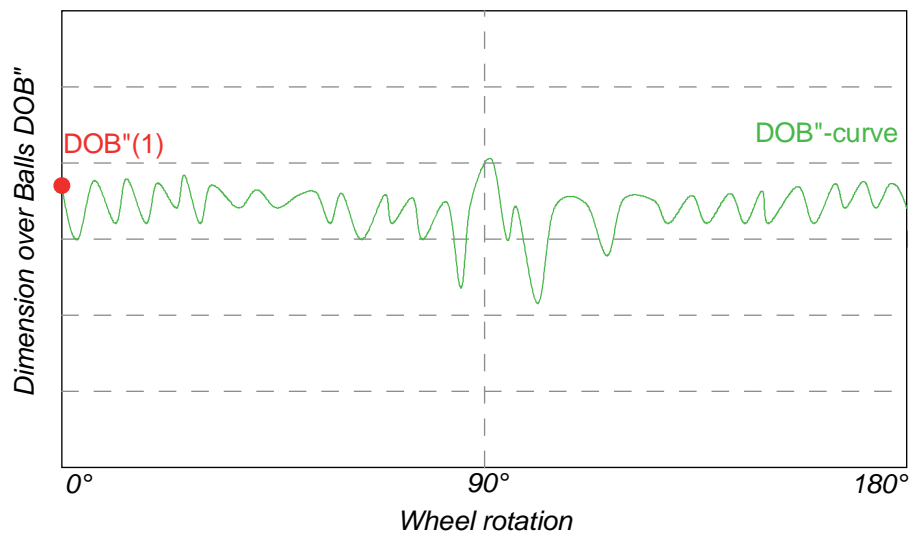

FRENCO-procedure for a reliable DOB''-Calculation at a glance:

- Consideration of even/odd number of teeth
- Independence of eccentricity
- Determination of the bore diameter

Optimisation by determining the bore diameter

To provide best possible estimates of the dimension over balls, the bore diameter is required. It has an immediate effect on the dimension calculated from the centre distance.

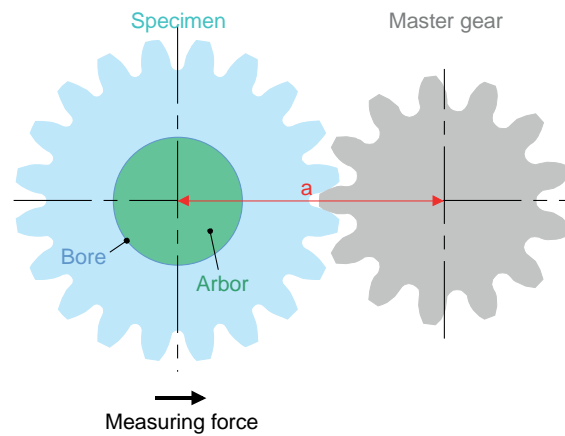

When the bore diameter is too large the measuring force pushes the arbor against the side of the master gear and the absolute dimension will be incorrect.

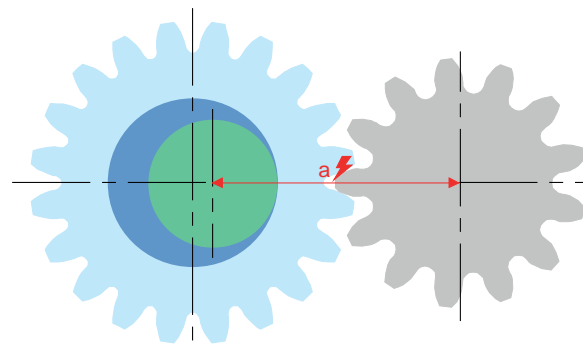

Only if the bore diameter is known, - including the diameter of the arbor- the offset can be calculated and compensated by the software.

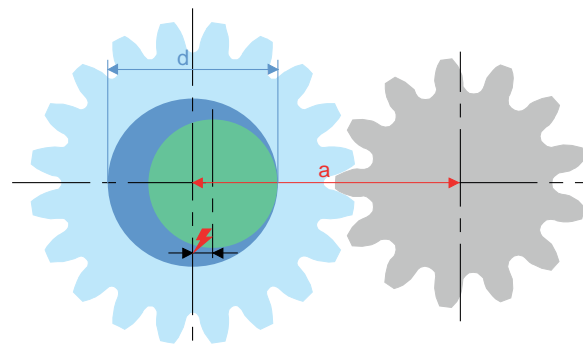

Size inspection of the workpiece bore

For larger tolerances in the mounting bore of the workpiece, the actual dimension of the bore should be recorded and used for the respective calculation of the centre distance. This considerably increases the accuracy of the calculated values for dimension over two balls, span size and tooth thickness.

The actual dimension of the bore can be measured e.g. with a bore measuring mandrel (air or tactile), which is already integrated in the mandrel of the workpiece.

Alternatively, the actual measurement can also be entered manually before the measurement if the value is recorded externally.

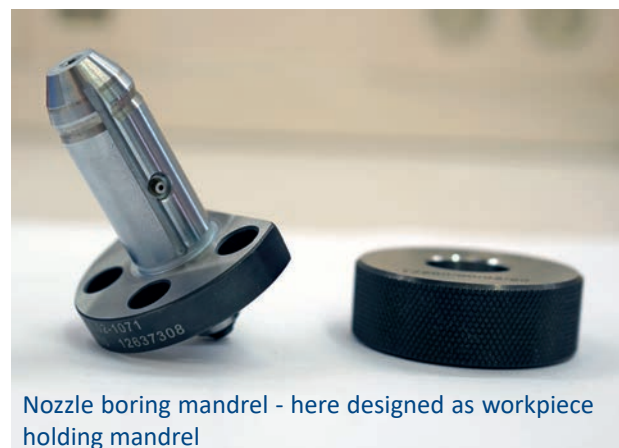

Correction of Deviations of Master Gears

Used to reduce the measurement uncertainty.

Master gears are manufactured with the same precision as gauges, they are high-precision items. However small form variations cannot be avoided. Especially the runout deviation causes a deviation in the double flank gear roll inspection which cannot be disregarded. The actual runout deviation of the master gear is considered in the measuring uncertainty with twice its value, because the deviations of the master gear and the workpiece superimpose each other positively or negatively depending on the angular position.

If the runout deviation of the master gear is 0.006 mm, the measuring uncertainty increases by 0.012 mm. This influence can be minimized by an increased accuracy of the master gear (e.g. using quality A according to the DIN 3970 (FRESCO QF)). By applying the correction of deviations of master gears this influence can be nearly completely avoided.

Correction of deviations of master gears:

The master gear or the driver has got a marking for the angular position which is read by a sensor. With a check master fitting to the master gear (number of teeth of the check master and number of teeth of the specimen must not have a common divisor) a correction run with multiple rotations is carried out. During this process the correction values are calculated and saved in the measuring electronic. With these calculated values the following measuring results are fully automatically corrected.

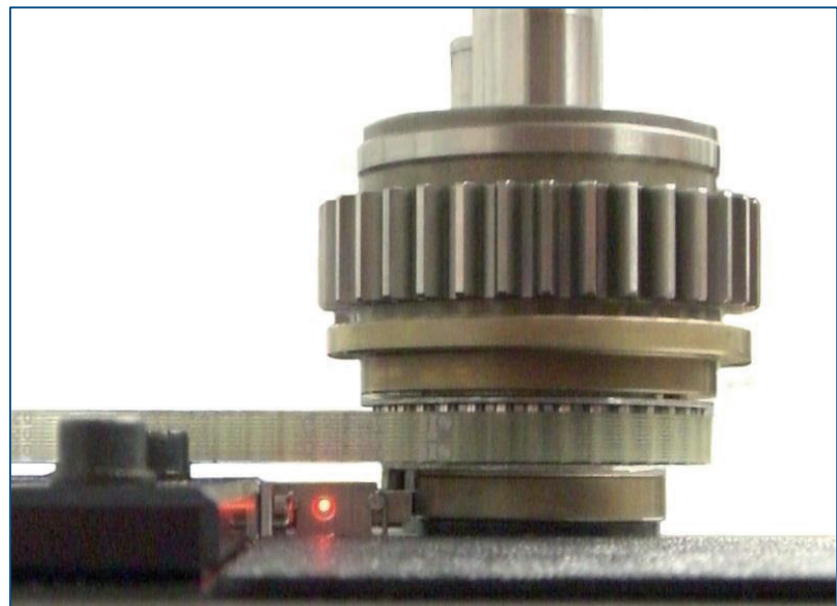
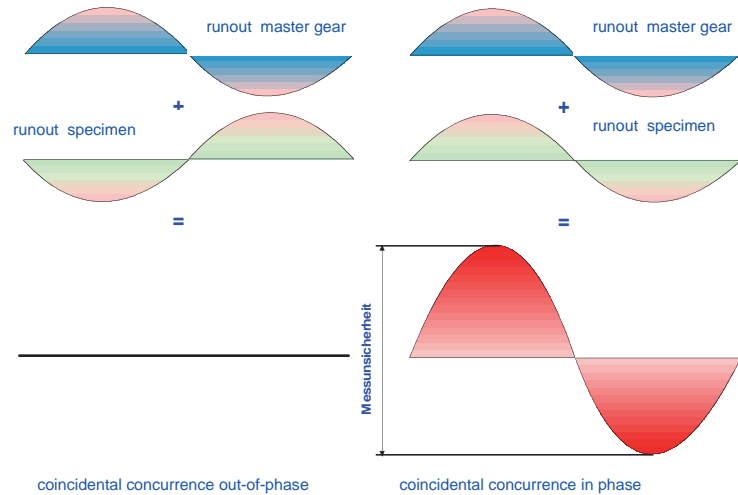

FRENCO Calibration Process

Used for traceability and determination of measurement uncertainties.

FRENCO calibrates double flank tester with its own limit value calibration kit. For the parameters of the double flank testn F_i'' , F_r'' and f_i'' are non-traceable parameters, as there are no reference values of the PTB (Physikalisch Technische Bundesanstalt) for them. For this reason, FRENCO has developed its own toothed „Artefact set“. Such a set consists of 5 masters. During the acceptance, maintenance and service, a calibration certificate is issued with the deviations that have occurred, which is suitable as the basis for test equipment monitoring, audits and certifications.



Reference Master

- is used as reference master
- no modifications
- tooth 1 is marked
- Rolling off with the other four masters



F'' - Calibration Master

- Has a runout modification
- leads to long-wave, sinusoidal F_r'' deviation



f'' - Calibration Master

- Has a tooth thickness-modification
- leads to short-wave f_i'' deviation



Setting master Centre distance

- has a certain tooth thickness
- is used to calibrate the centre distance



Control Master

- has a different tooth thickness than the Setting master Centre distance
- vspecified nominal dimension that can be used as a Actual dimension must be displayed

FRENCO pure perfection

QM System im DAkkS Kalibrierlaboratorium für Verzahnungsmessgrößen nach DIN EN ISO/IEC

Werks-Kalibrierschein Calibration Certificate

Gegenstand	Zweiflanken-Walzprüfgerät	Dieser Kalibrierschein dokumentiert die Rückführung auf Werksnormale zur Darstellung der Einheiten in Übereinstimmung mit dem Internationalen Einheitensystem (SI).
Object		
Hersteller	FRENCO GmbH	Für die Einhaltung einer angemessenen Frist zur Wiederholung der Kalibrierung ist der Benutzer verantwortlich.
Manufacturer		
Typ	ZWG 8305	
Type		
Fabrikat/Serien-Nr.	254711	This calibration certificate documents the traceability to standards, which realize the units of measurement according to the International System of Units (SI).
Serial number		
Auftraggeber	MUSTERFRAU GmbH	The user is obliged to have the object re-calibrated at appropriate intervals.
Customer	Jakob-Bayer-Str. 4711 90518 Altdorf	
Auftragsnummer	Z72/45004712	
Order No.	201221107	
Anzahl der Seiten des Kalibrierscheines	4	
Number of pages of the certificate		
Datum der Kalibrierung	18.02.2013	
Date of calibration		

⊗ Die Messwerte liegen innerhalb der Spezifikation
 ○ Die Messwerte liegen außerhalb der Spezifikation

Dieser Kalibrierschein darf nur vollständig und unverändert weiterverbreitet werden. Auszüge oder Änderungen bedürfen der Genehmigung des ausstellenden Kalibrierlaboratoriums. Kalibrierscheine ohne Unterschrift haben keine Gültigkeit.
 This calibration certificate may not be reproduced other than in full except with the permission of the issuing laboratory. Calibration certificates without signature are not valid.

Datum
Date

Bearbeiter
Person in charge

Traceability

The Physikalisch-Technische Bundesanstalt (PTB) does not offer traceability for characteristic values of the double flank test. This means, F_i'' , f_i'' , F_r'' and f_k'' are not calibrated there.

FRENCO is probably the only company in the world that is able to calibrate the parameters F_i'' , f_i'' , F_r'' and f_k'' of double flank testers and gears.

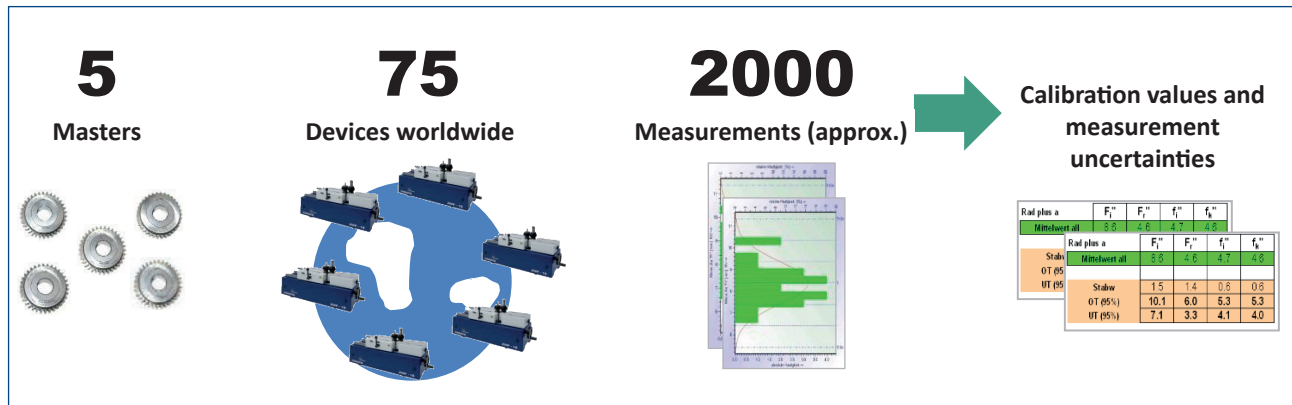

For this purpose, a limit value calibration set consisting of 5 masters was measured approx. 2000 times on 75 different double flank gear roll inspection machines from all over the world under calibration conditions.

All measurement results were analysed using statistical methods, outliers eliminated and finally mean values and action limits calculated. Finally, the calibration values F_i'' , f_i'' , F_r'' , f_k'' as well as the measurement uncertainty $U_{F_i''}$, $U_{f_i''}$, $U_{F_r''}$ and $U_{f_k''}$ can be calculated from this. There are now 12 such limit value calibration sets worldwide, 5 of which have different geometries at FRENCO.

What's that needed for?

- for calibration of double flank tester
- for the evaluation of the double flank tester
- to determine the measurement uncertainty
- for conformity assessments

Measurement Uncertainty

The limit value calibration set makes it possible to determine the measurement uncertainty of a double flank tester. The standardized procedure U_{MS} according to VDA-5 is applied. We coordinate the underlying characteristic values and tolerances with you.

The following characteristic values can be directly traced back

- Diametrical dimension over two balls
- Tooth thickness
- Centre distance

The uncertainties are traceable to PTB's measurements.

Indirectly traceable can be the characteristic values

- Double flank rolling deviation F_i''
- Double flank rolling tooth-to-tooth deviation f_i''
- Composite runout deviation F_r''

The uncertainties are related to stable mean values of very large samples.

By knowing the measurement uncertainty, the test planner knows whether the test equipment can be used for the measurement task. QM systems require the determination of the measurement uncertainty. This has to be proven during quality audits.

Retrofit

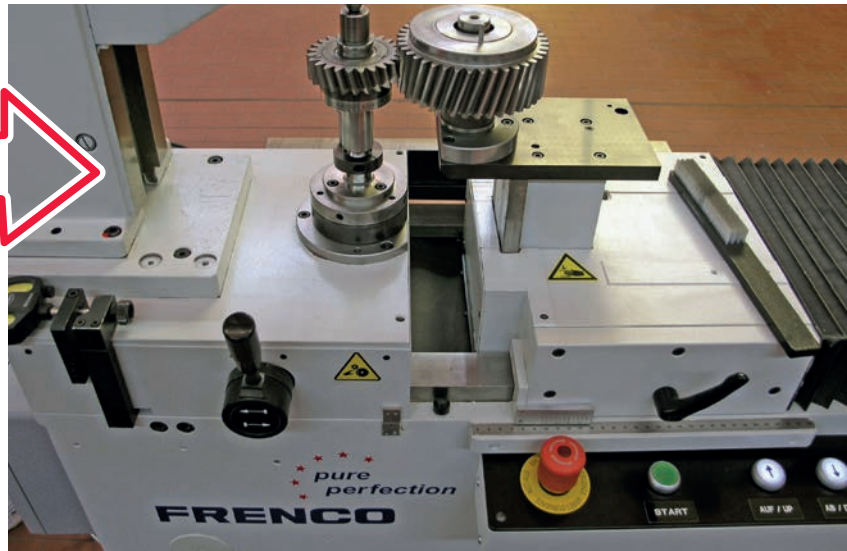
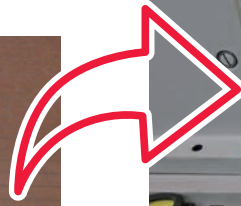
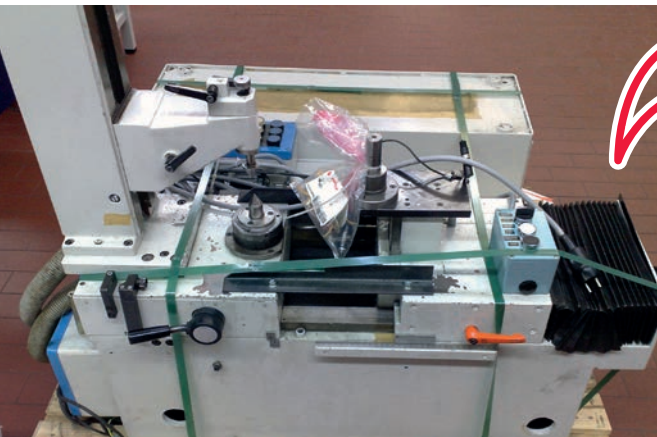

FRENCO-Retrofitting for used Double Flank Gear Testers

FRENCO retrofits earlier double flank gear testers with the powerful MEG 32 measuring electronics and the FGI pro evaluation software. The retrofit is possible for all below mentioned machine types. No matter if they ran until now with pen recorder or earlier electronics.

For retrofitting, please send the machine to FRENCO GmbH. The device will be dismantled, cleaned and smaller repairs will be carried out. Furthermore, probe and motor will be replaced and an emergency-stop button will be installed (unless one is already installed). The double flank gear tester will be completely refurbished!

The following devices can be retrofitted:

- Mahr 894B, 896B, 898B, 898C
- Hommel ZWG8305, ZWG8315
- Höfler ZW300
- other types on request

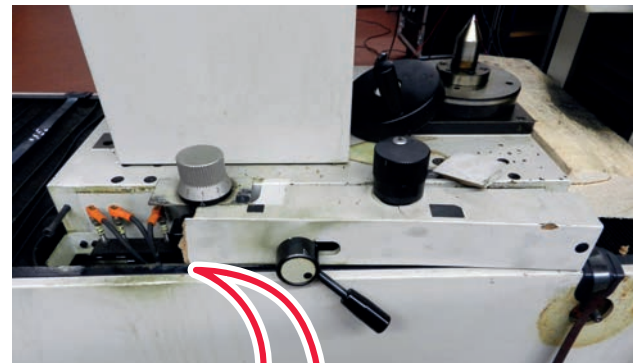

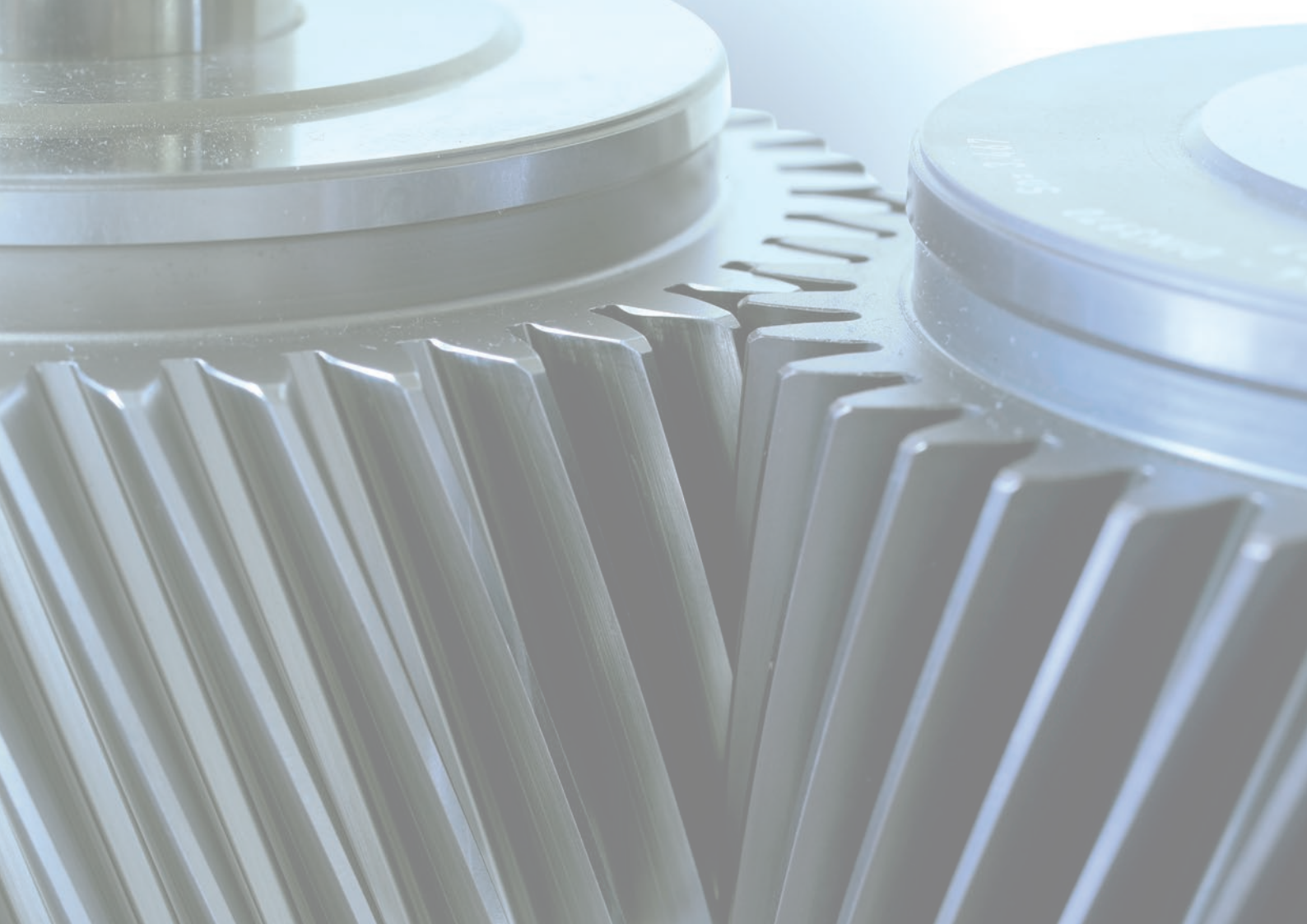

Pure Perfection. Since 1978.

Experience, competence and innovation in gear metrology.



Our Products:

Spline Gauges | Toothed Artefacts and Masters | Master Gears |
Tools and Clamping Systems | Size Inspection Instruments |
Double Flank Gear Inspection | Gear Flank Analyser | Universal
Measuring Machines | Rack Inspection Machines | Software

Our Services:

DAKKS Calibration | Gear and Spline Inspection |
Gear and Spline Manufacturing | Seminars | Service |
Support and Calculation

Phone: +49 (0) 9187 95 22 0

FRENCO GmbH

Gear + Spline Technology

Jakob-Baier-Str. 3 • D - 90518 Altdorf

www.frenco.com



FRENCO